

## LOCATION OF LABELS

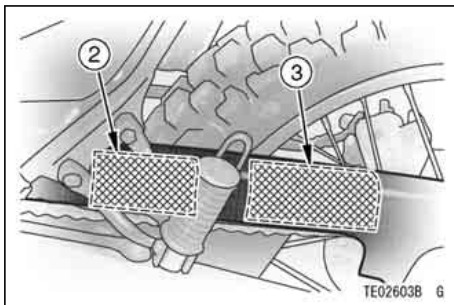

1. Important Break-In Instructions
2. Tire and Load Data
3. Important Drive Chain Information
4. Vehicle Emission Control Information
5. Daily Safety Checks

(For further information of label, refer to the "LABEL INFORMATION" chapter.)

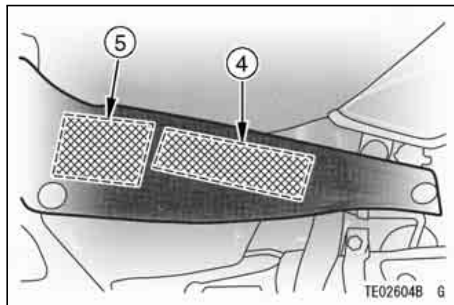
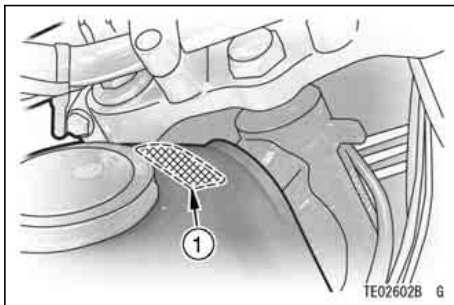
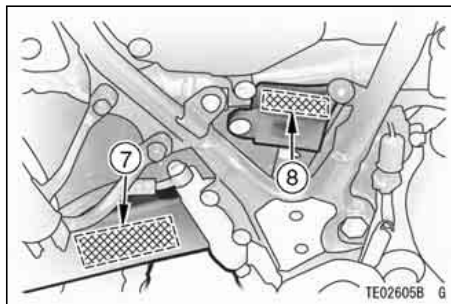
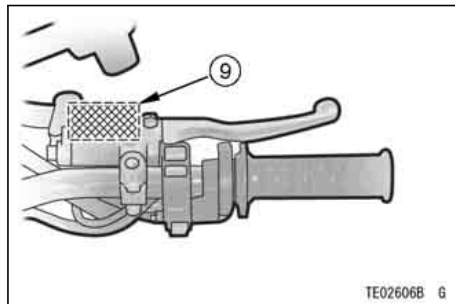
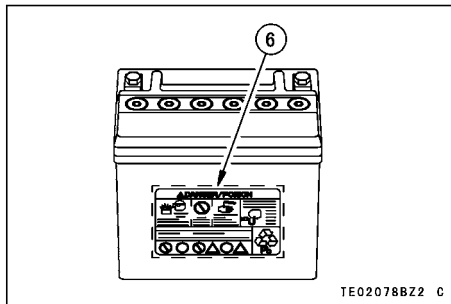

- 6. Battery Poison/Danger
- 7. Engine Oil and Oil Filter
- 8. Brake Fluid (Rear)
- 9. Brake Fluid (Front)

(For further information of label, refer to the "LABEL INFORMATION" chapter.)

## 18 LOCATION OF LABELS

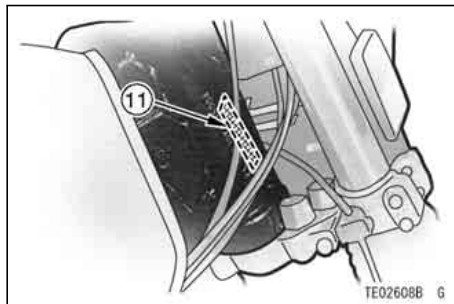
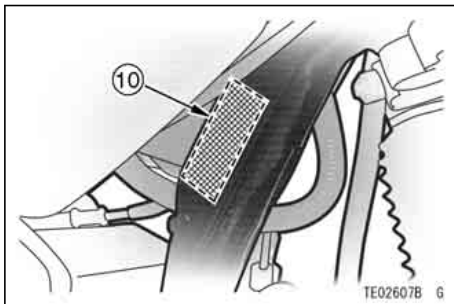

- 10. Noise Emission Control Information
- 11. Weight and Manufacture

(For further information of label, refer to the “LABEL INFORMATION” chapter.)